

TOCĂTOR HACCP

Fabricat din polietilenă HDPE 500

Respectă standardele HACCP

Ambele părți potrivite pentru tăiere

**TOCĂTOR HACCP 600X400**

Cod	Culoare	mm	Pentru
825600	alb	600x400x(H)18	produse lactate, pâine
825617	roșu	600x400x(H)18	carne crudă
825624	albastru	600x400x(H)18	pește
825631	verde	600x400x(H)18	legume, fructe
825648	maro	600x400x(H)18	carne gătită
825655	galben	600x400x(H)18	carne crudă de pasăre

TOCĂTOR HACCP 450X300

Cod	Culoare	mm	Pentru
825518	alb	450x300x(H)12,7	produse lactate, pâine
825525	roșu	450x300x(H)12,7	carne crudă
825532	albastru	450x300x(H)12,7	pește
825549	verde	450x300x(H)12,7	legume, fructe
825556	maro	450x300x(H)12,7	carne gătită
825563	galben	450x300x(H)12,7	carne crudă de pasăre



TOCĂTOR HACCP GASTRONORM 1/1

O parte netedă și o parte cu canelură pe margine

Cod	Culoare	mm	Pentru
826003	alb	530x325x(H)15	produse lactate
826010	roșu	530x325x(H)15	carne crudă
826027	albastru	530x325x(H)15	pește
826034	verde	530x325x(H)15	legume
826041	maro	530x325x(H)15	cârnați, carne gătită
826058	galben	530x325x(H)15	carne crudă de pasăre

TOCĂTOR HACCP GASTRONORM 1/2

O parte netedă și o parte cu canelură pe margine

Cod	Culoare	mm	Pentru
826102	alb	265x325x(H)12	produse lactate
826119	roșu	265x325x(H)12	carne crudă
826126	albastru	265x325x(H)12	pește
826133	verde	265x325x(H)12	legume
826140	maro	265x325x(H)12	cârnați, carne gătită
826157	galben	265x325x(H)12	carne crudă de pasăre

SUPORT TOCĂTOARE

Pentru 6 bucăți tocătoare



Cod	mm
826201	303x211x(H)205



826201

Canelură pentru a preveni scurgerea

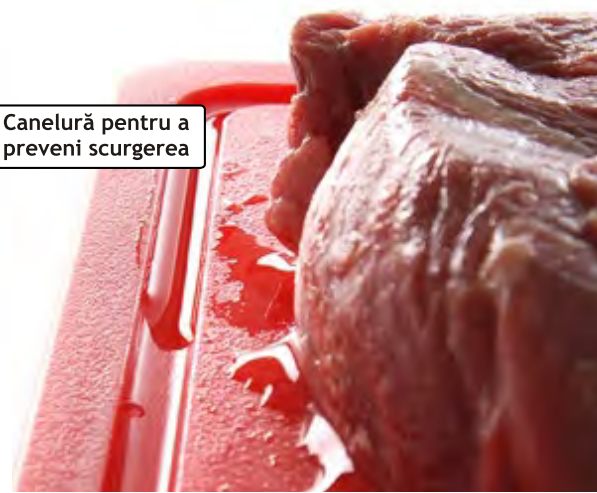



826300

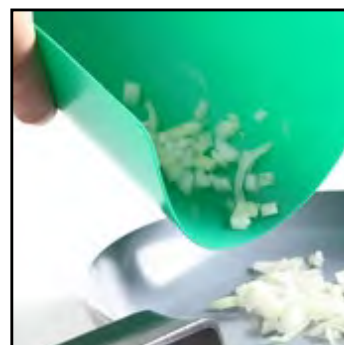

TOCĂTOR SUBȚIRE HACCP - SET DE 6 BUCĂȚI

Set de 6 bucăți, culori diferite pentru ușurință igienizare
Alb, roșu, albastru, verde, maro, galben
Flexibil pentru a permite manevrarea ușoară a produselor tăiate
Ușor de depozitat

Cod	mm
826300	380x305x(H)1,4

598047

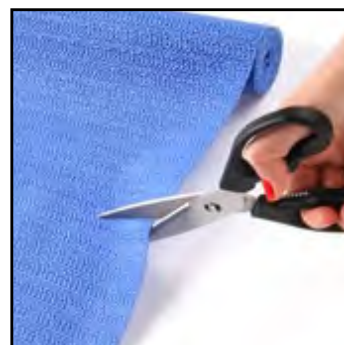

SUPORT ANTI-ALUNECARE

Suport anti-alunecare multifuncțional
Fabricat din spumă PVC
Se poate tăia la dimensiunea dorită folosind foarfeca
Se spală de mână, la 40 ° C

Cod	mm
598047	1500x300



506943

NOU!



506936

TOCĂTOARE BAMBUS

Cod	mm
506936	500x350x(H)40
506943	330x250x(H)40

NOU!



506950

TOCĂTOR BAMBUS

Cod	mm
506950	ø400x(H)35

TOCĂTOR LEMN

506912



506905

TOCĂTOR

Lemn de cauciuc de înaltă calitate
Cu mâner



Cod	-	mm
506912	GN 1/2	265x325x(H)45
506905	GN 1/1	530x325x(H)45



505205

TOCĂTOR SCULPTAT

Tocător solid de fag
Cu șanțuri



Cod	mm
505205	390x230x(H)16



505007

TOCĂTOR PENTRU PÂINE

Din lemn de fag, solid



Cod	mm
505007	340x200x(H)14



505106

TOCĂTOR

Cu mâner
Din lemn de fag, solid



Cod	mm
505106	390x160x(H)13



Cu grătar
detașabil



505502

TOCĂTOR PENTRU BAGHETE

Din lemn, cu grătar detașabil
Cu 4 picioare anti-alunecare



Cod	mm
505502	475x322



505403

TOCĂTOR PENTRU BAGHETE

Tocător masiv din frasin
Model combinat, 1 parte cu șanțuri și 1 parte
cu nervuri laterale



Cod	mm
505403	530x325x(H)18



CUȚITE SERIA PROFI LINE

Toate cuțitele sunt produse din oțel german inoxidabil. Aliajul de oțel X50CrMoV15 garantează următoarele caracteristici:

- Tăiș ascuțit
- Tăiș de lungă durată
- Ușor de ascuțit

Rezistență ridicată la pete. Aproximativ 50 de pași importanți de producție sunt necesari pentru a produce fiecare cuțit. Tehnicilor tradiționale și mașinilor de precizie li se adaugă operațiunile de șlefuire și poleială. Manerul combină echilibrul, siguranța, ușurința de folosire cu un aspect exclusiv. Fiecare cuțit este ambalat individual într-un blister de prezentare din PET



Cod	Nr		Lamă mm	Grosime (mm)
844205	1	Cuțitul bucătarului	250/385	3,3
844212	2	Cuțitul bucătarului	200/335	3,3
844311	3	Cuțit feliere	250/380	2,7
844304	4	Cuțit feliere	200/330	2,6
844267	5	Cuțit dezosare	Flexibil 150/270	2
844250	6	Cuțit de bucătărie	150/265	2
844236	7	Cuțit decojire	90/195	1,9



Tăiș Granton pentru
o tăiere fără lipire

Tăiș Granton pentru
o tăiere fără lipire

Tăiș Granton pentru
o tăiere fără lipire

Cod	Nº	-	Lamă mm	Grosime (mm)
844403	1	Pilă diamant ascuțit cuțite	oval	310/445
844328	2	Cuțit șuncă/somon	tăiș Granton	300/430 2,6
844298	3	Cuțit pâine		215/340 2,4
844281	4	Bread knife	offset	215/340 2,4
844342	5	Cleaver	versiune simplă	170/295 4
844335	6	Satâr	tăiș Granton	170/295 2,5
844274	7	Cuțit Santoku	tăiș Granton	180/310 3
844229	8	Furcă pentru carne		150/285 9
844243	9	Furculiță curbată carne		130/255 2,5

CUȚITE SERIA KITCHEN LINE

Realizate dintr-o bucată de oțel crom-molibden forjat

Datorită manoperei de înaltă calitate, cuțitele Hendi sunt durabile și rezistente la coroziune, tăișul lamei având rezistență mare în timp

Un design unic al mânerului previne pătrunderea de reziduuri alimentare între lamă și mâner

Fiecare cuțit este ambalat individual într-un blister de prezentare din PET

Mâner ergonomic din bachelită



Cel mai vândut!



Cod	Nº		Lamă mm
781319	1	Cuțitul bucătarului	200/340
781357	2	Cuțitul bucătarului	150/295
781340	3	Cuțit decorare	200/330
781371	4	Cuțit dezosare	150/285
781333	5	Cuțit pâine	230/345
781388	6	Cuțit de bucătărie	125/240
781395	7	Cuțit decojire	90/200



1



2



3



4



5

Cod	Nº		mm int	Lamă mm
781401	1	Foarfecă dezosare pasăre		140/250
781364	2	Furculiță pentru carne		175/290
781302	3	Satâr		180/300
781326	4	Cuțit șuncă/somon		215/380
781418	5	Pilă ascuțit cuțite	Ø10	230/360

MAGNET CUȚITE CU AGĂȚĂTORI

Cu 2 benzi magnetice



Cod	L mm	Accesorii
820209	300	3 cârlige
820308	450	5 cârlige
820407	600	6 cârlige



820209



820308



820407

CUȚITE JAPONEZE

Serie de top

Fabricate din aliaj de carbon oțel X50CrMoV15

Produce în 50 de etape importante de fabricație

Mâner tradițional din lemn

Fiecare cuțit este ambalat individual într-un blister de prezentare din PET

Ediție limitată, fabricate special pentru HENDI



Cod	Nº		Lamă mm	Grosime (mm)
845059	1	Cuțit "Sashimi"	210/340	4
845042	2	Cuțit "Sashimi"	240/370	4
845028	3	Cuțit "Nakiri"	180/325	4
845035	4	Cuțit "Santoku"	165/295	2



NEGRU - UNIVERSAL

Fiecare cuțit este ambalat individual într-un blister de prezentare din PVC

Mâner polipropilenă, în conformitate cu normele HACCP



Tăiș Granton pentru
o tăiere fără lipire



Cod	Nº	Model	Lamă mm	Grosime (mm)
842201	1	Cuțit universal model scurt	90/190	1,2
842102	2	Cuțit universal zimțat	100/205	1,2
842409	3	Cuțit pentru decupare	150/280	2,5
842607	4	Cuțitul bucătarului	180/320	2,5
842706	5	Cuțitul bucătarului	240/385	2,5

Cod	Nº	Model	Lamă mm	Grosime (mm)
842904	6	Cuțit șuncă/somon	350/490	1,7
843000	7	Cuțit pâine	250/385	1,5
843109	8	Bread knife	300/430	1,5
781418	9	Pilă ascuțit cuțite	230/360	Ø10

MARO - CARNE GĂTITĂ

Fiecare cuțit este ambalat individual într-un blister de prezentare din PVC

Mâner polipropilenă, în conformitate cu normele HACCP



Cod	Nº		Lamă mm	Grosime (mm)
842669	1	Cuțitul bucătarului	180/320	2,5
842799	2	Cuțitul bucătarului	240/385	2,5
842966	3	Cuțit șuncă/somon	350/490	1,7

Tăiș Granton pentru o tăiere fără lipire



1



2



3

**ROȘU - CARNE CRUDĂ**

Fiecare cuțit este ambalat individual într-un blister de prezentare din PVC

Mâner polipropilenă, în conformitate cu normele HACCP

Cod	Nº		Lamă mm	Grosime (mm)
842423	1	Cuțit pentru decupare	150/290	2,5
842522	2	Cuțit pentru filetat	150/300	0,9
842621	3	Cuțitul bucătarului	180/320	2,5
842720	4	Cuțitul bucătarului	240/385	2,5
842928	5	Cuțit șuncă/somon	350/490	1,7

Tăiș Granton pentru o tăiere fără lipire



1



2



3



4



5



GALBEN - CARNE DE PASĂRE

Fiecare cuțit este ambalat individual într-un blister de prezentare din PVC

Mâner polipropilenă, în conformitate cu normele HACCP



Cod	NP		Lamă mm	Grosime (mm)
842539	1	Cuțit pentru filetat	150/300	0,9
842638	2	Cuțitul bucătarului	180/320	2,5
842737	3	Cuțitul bucătarului	240/385	2,5



1

2

3

ALBASTRU - PEȘTE

Fiecare cuțit este ambalat individual într-un blister de prezentare din PVC

Mâner polipropilenă, în conformitate cu normele HACCP

Cod	NP		Lamă mm	Grosime (mm)
842546	1	Cuțit pentru filetat	150/300	0,9
842645	2	Cuțitul bucătarului	180/320	2,5
842744	3	Cuțitul bucătarului	240/385	2,5



1

2

3

ALB - BRÂNZETURI ȘI PÂINE

Fiecare cuțit este ambalat individual într-un blister de prezentare din PVC

Mâner polipropilenă, în conformitate cu normele HACCP



Cod	Nº	Model	Lamă mm	Grosime (mm)
842256	1	Cuțit universal model scurt	90/190	1,2
842355	2	Cuțit universal model lung	130/230	1,2
842553	3	Cuțit pentru filetat	150/300	0,9
842652	4	Cuțitul bucătarului	180/320	2,5
842751	5	Cuțitul bucătarului	240/385	2,5
843055	6	Cuțit pâine	250/385	1,5
843154	7	Bread knife	300/430	1,5



Tăiș Granton pentru o tăiere fără lipire

Tăiș Granton pentru o tăiere fără lipire

1 2 3 4 5 6 7

VERDE - FRUCTE ȘI LEGUME

Fiecare cuțit este ambalat individual într-un blister de prezentare din PVC

Mâner polipropilenă, în conformitate cu normele HACCP

Cod	Nº	Model	Lamă mm	Grosime (mm)
842218	1	Cuțit universal model scurt	90/190	1,2
842119	2	Cuțit universal zimțat	100/205	1,2
842317	3	Cuțit universal model lung	130/230	1,2
842614	4	Cuțitul bucătarului	180/320	2,5
842713	5	Cuțitul bucătarului	240/385	2,5



Tăiș Granton pentru o tăiere fără lipire

Tăiș Granton pentru o tăiere fără lipire

1 2 3 4 5

CUȚITE DECOJIRE - SET DE 6 CULORI



842003

CUȚIT DECOJIRE

Set cu 6 culori diferite: alb, roșu, albastru, verde, negru și galben
Fabricate din oțel laminat

Cod	Lamă mm
842003	75/175



842010

CUȚIT DECOJIRE

Set cu 6 culori diferite: alb, roșu, albastru, verde, negru și galben
Fabricate din oțel laminat

Cod	Lamă mm
842010	90/185

CUȚITE DECOJIRE ȘI APARATE PENTRU CURĂȚAT

Calitate înaltă



CUȚIT PENTRU DECOJIRE

"Made in Germany"

Cod	Model	Lamă mm
841105	model drept	75/180
841112	model ascuțit	87/190
841129	model curbat	60/165



CUȚIT PENTRU ROȘII

Mâner polipropilenă
"Made in Germany"

Cod	Lamă mm
841136	110/210



CUȚIT PENTRU DECOJIT CU MÂNER DIN LEMN

"Made in Germany"

Cod	Model	Lamă mm
841020	model curbat	60/165



DECOJITOR

Model transversal

Cod	Lamă mm
841228	50/110



CURĂȚITOR

Model lateral

Cod	Lamă mm
841235	50/150



841020



841228



841235



**CUȚIT PENTRU FELIAT**

Cod	mm
856208	205

**CUȚIT PENTRU FELIAT BRÂNZETURI MOI**

Cod	mm
856215	160

**RĂZĂTOARE BRÂNZETURI**

Cod	mm
856222	255x60

**CUȚIT PENTRU BRÂNZETURI MOI**

Cod	mm
856246	160

**CUȚIT PENTRU BRÂNZETURI TARI**

Cod	mm
856239	130



FELIATOR PIZZA

Cod	-	mm
617014	1 bucată per ambalaj	Ø 100x230



CUȚIT TĂIERE ALUAT - LAMĂ ZIMȚATĂ

Cod	-	mm
856154	60 mm	180



CUȚIT LĂMÂIE

Cod	mm
856031	155



CUȚIT DE ÎNTINS - ZIMȚAT

Cod	mm
855768	225



**DECOJITOR CARTOFI**

Cod	mm
856178	175

**CUȚIT DECORARE**

Cod	-	mm
856062	zimțat - 90 mm	200

**CUȚIT PENTRU ROȘII**

Cod	-	mm
856253	zimțat - 110 mm	230

**CUȚIT MERE**

Cod	-	mm
856079	diametru 20 mm, lungime 100 mm	215



CUȚIT UNT

Cod	-	mm
856192	zimțat	200



CUȚIT GRAPEFRUIT

Cod	-	mm
856185	110 mm	215



CUȚIT LEGUME

Cod	-	mm
856086	110 mm	220



DECOJITOR CITRICE

Cod	-	mm
856055	180	





LINGURIȚĂ PEPENE OVALĂ

Cod		mm
856017	26 mm	165



LINGURIȚĂ ZIMȚATĂ

Cod		mm
856024	zimțată - 22 mm	155



LINGURIȚĂ PEPENE DUBLĂ

Cod		mm
856000	ø 22-25 mm	165



CUȚIT CANAL

Cod		mm
856048		150

USTENSILE DECORARE



856291



SET UNELTE DECORARE - 6 PIESE

Conține:

- Linguriță pepene dublă
- Linguriță pepene zimțată
- Cuțit lămâie
- Cuțit canal
- Cuțit mere
- Cuțit decorare

Cod

856291



CUȚITE DE TOCAT



844366

844359

CUȚIT PENTRU TOCAT

Cod		mm
844366	lamă dublă	230
844359	o singură lamă	230



FOARFECĂ DEZOSAT CARNE PASĂRE

Oțel carbon de înaltă calitate
Mâner moale

Cod	mm
856314	240

856314

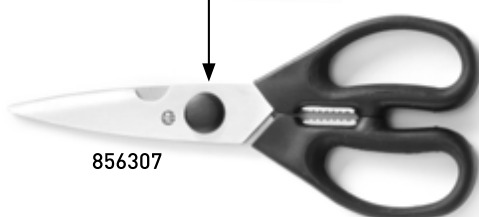
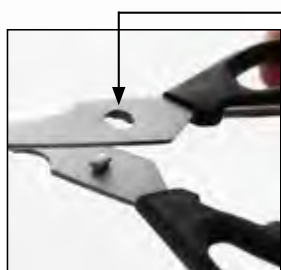

856307

FOARFECI DE BUCĂTĂRIE

Detășabilă - ușor de curățat
Mâner moale

Cod	mm
856307	195



224403

DISPOZITIV PENTRU ASCUȚIT CUȚITE

Potrivit pentru o ascuțire rapidă și ușoară a cuțitelor

Șmirghel ușor de schimbat

Potrivit pentru toate tipurile de cuțite pentru carne, pește, legume și fructe

Cod	mm	V	W
224403	310x110x(H)110	230	50

224410 Șmirghel - piesă schimb



820605

DISPOZITIV ASCUȚIT CUȚITE

Cu protecție pentru degete

Cod	mm
820605	140

**NOU!**

820612

DISPOZITIV ASCUȚIT CUȚITE

Mânerul ergonomic și baza antialunecare oferă siguranță și confort

3 funcții pentru ascuțirea tuturor tipurilor de cuțite, chiar și pe cele ceramice

A nu se folosi pentru ascuțirea lamelor zimțate sau foarfecilor

Cod	mm
820612	200x46x(H)75

CERAMIC
[ceramic]: tije galvanizate încrucișate pentru cuțite ceramice

COARSE [brut]:
dispozitiv de ascuțire din carbură de calciu pentru obținere tăiș

FINE [fin]:
tije ceramice încrucișate pentru ajustarea profesională a tăișului



PRESE ȘI APARATE DE PASAT

ZDROBITOR CARTOFI

Model solid



Cod	mm
693001	130x(H)355
693100	180x(H)600
693209	180x(H)770



ZDROBITOR CARTOFI

Cod	mm
856147	95x(H)230



856147



693001



693100



693209



NOU!



515105

PRESĂ CARTOFI

Cod	mm
515105	300x110



570715

PRESĂ USTUROI

Cod	mm
570715	175x30



856123

PRESĂ USTUROI

Ușor de curățat
2 grătare detașabile

Cod	mm
856123	180x25





570104

FELIATOR OU -
DREPTUNGHILAR



Cod	mm
570104	130x85



570012

FELIATOR OU -
OVAL



Cod	-	mm
570012	1 pe carton	120x115

Previne spargerea în
timpul fierberii



441435

DISPOZITIV PENTRU OU



Cod	-	mm
441435	pe carton	Ø57(H)31



690000



DESCHIZĂTOR CONSERVE

Incluce set prindere de masă
Potrivit pentru cutii de până la 400 mm

Cod	mm
690000	550



856116



DESCHIZĂTOR CONSERVE

Cod	mm
856116	200

CAPAC ANTI-STROPIRE

Sita fină permite vaporilor de apă să treacă,
pentru o crustă crocantă. Fără pete de
grăsime.

Cod	mm
646625	Ø300



646625



NOU!



513705



SUPORT BONURI/FILE

Fabricat din aluminiu lucios
Se fixează cu șuruburi sau adeziv

Cod	mm
513705	600

Adecvat pentru vase
cu diametrul cuprins
între 20 și 28 de cm.





Lame tăiere în formă de V



TĂIETOR LEGUME TIP V

Confecționat din plastic rezistent negru
 Include 5 lame din oțel inoxidabil de înaltă calitate
 Suport pliabil cu picioare din cauciuc
 Sistem de prindere cu ace metalice pentru produs
 Înălțime 140 mm (cu suportul desfășurat)

Cod	mm
222614	130x335x(H)75

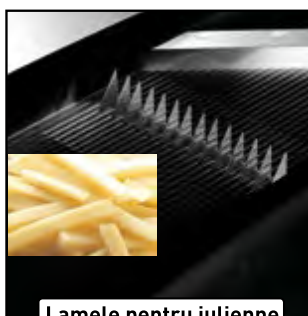

Lamele pentru julienne și cartofi french de 6 mm sau 9 mm



Grosimea feliei reglabilă de la 1 mm la 9 mm



222652



2 lame pentru tăiat (1 lamă pentru tăiere ondulată) și 3 lame pentru tăiere jullienne (4, 6, 10 mm).



MANDOLINĂ

Cutie de depozitare pentru lame, prindere legume în timpul tăierii.
 Stativ anti-alunecare.

Cod	mm
222652	395x125x(H)200

**NOU!**

856352



856369



856376

RĂZĂTORI

Lame de tăiere de înaltă precizie, extrem de ascuțite

Cod	-	mm
856352	fină	35x220 / (L)390
856369	grosieră	35x220 / (L)390
856376	fâșii	35x220 / (L)390

**NOU!**

856321

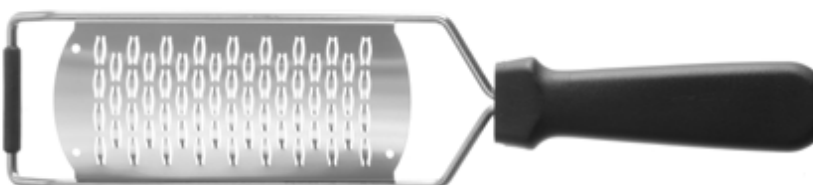

856338



856345

RĂZĂTORI

Lame de tăiere de înaltă precizie, extrem de ascuțite

Cod	-	mm
856321	grosieră	65x135 / (L)315
856338	fâșii	65x135 / (L)315
856345	răzuire	65x135 / (L)315



TĂIETOR CARTOFI PRĂJIȚI (FRENCH)

Cuțite din oțel inoxidabil
 Conține 4 cuțite: 6, 9 și 13 mm precum și cuțit
 pentru tăiere în 8 bucăți
 Se montează pe masa de lucru sau pe perete

Cod	mm
630402	430x168x(H)290



RĂZĂTOARE CU 4 FEȚE

Cod	mm
443002	90x65x(H)200



Solid
design



505694

Bază
armată**BUTUC LEMN PE SUPT DİN LEMN**

Fabricat din lemn de fag
Înălțime suport 720 mm

Cod	mm
506011	500x400x(H)200
505694	500x400x(H)150
505625	400x400x(H)150
505618	400x400x(H)110



505687

HDPE

POLYETHYLENE

S.S.

STAINLESS STEEL

BUTUC DİN POLIETILENĂ CU SUPT

Fabricat din polietilenă HDPE500
Cadru armat din oțel inoxidabil
Înălțime suport 750 mm

Cod	mm
505687	500x400x80

BUTUC DİN POLIETILENĂ FĂRĂ SUPT

Fabricat din polietilenă HDPE500

Cod	mm
505663	500x400x(H)80
505656	500x400x(H)150

SUPT BUTUC

Cadru armat
Pentru butuc 505656 & 505663

Cod	mm
505670	500x400x(H)750

BUTUC LEMN FĂRĂ SUPT

Fabricat din lemn de fag

Cod	mm
505649	500x400x(H)200
505632	500x400x(H)150

CÂRLIGUL MĂCELARULUI - SET DE 4 BUCĂȚI

Cod	mm
513538	90x4
513545	110x5
513552	130x5
513569	150x6

SFOARĂ

Bobină cu 100 g de sfoară
Fabricată din bumbac nealbit
Cca 85 m

Cod	Ambalat per
559208	1



505632

Suprafață de lucru
impregnată cu uleiPărți laterale
lăcuite

513538



559208



Cel mai vândut!

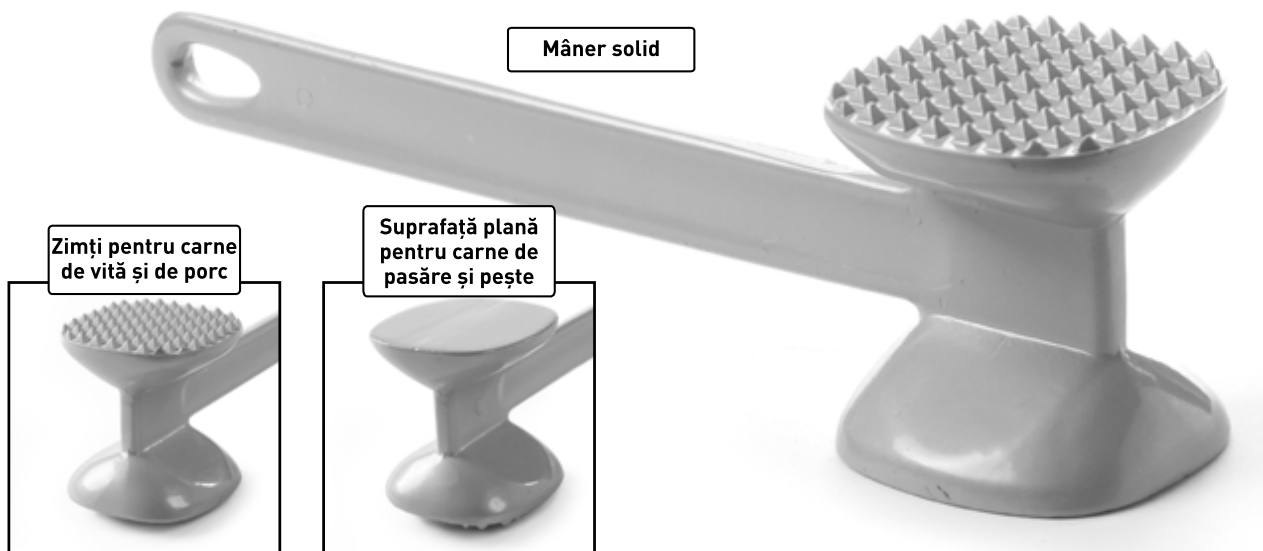

Mâner solid

Zimți pentru carne de vită și de porc

Suprafață plană pentru carne de pasăre și pește

513002

CIOCAN PENTRU FRĂGEZIREA CĂRNII

Cod	L mm
513002	220

DISPOZITIV FRĂGEZIRE CARNE PROFI LINE

Instrument modern și eficient pentru tratarea mecanică a cărnii, lamele verticale reduc lungimea fibrelor din carne
Frăgezește perfect carnea și o aplatizează în același timp
Timpul de marinare poate fi redus cu până la 25% deoarece suprafața de contact a cărnii cu condimentele este crescută semnificativ
În timpul prăjirii sosurile pătrund mai ușor în carne
Se poate spăla la mașina de spălat vase

Cod	Culoare	Tip	mm
843451	albastru	45 lame	145x45x(H)103

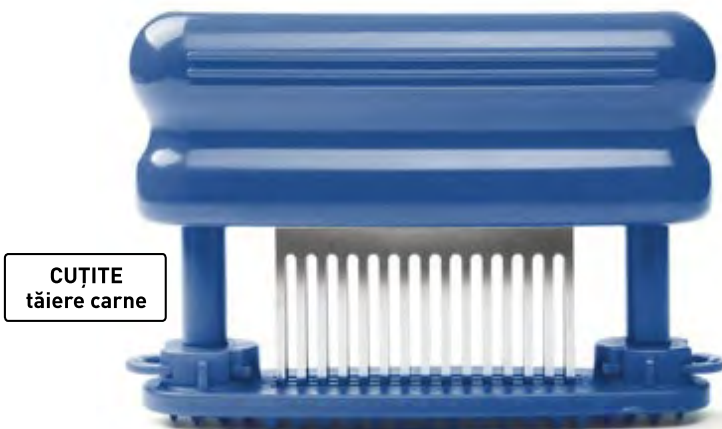

CUȚITE tăiere carne

PIRAMIDE aplatizare carne



SUPRAFAȚĂ PLANĂ ciocan de carne tradițional

CUȚITE tăiere carne

PIRAMIDE aplatizare carne

CIOCAN PENTRU CARNE PROCHEF

Combină între aparat de frăgezit și ciocan tradițional pentru frăgezit
Frăgezește perfect carnea și o aplatizează în același timp
Echipat cu 56 lame din oțel inoxidabil
Piramidele aplatizează carnea
Cuțitele taie din carne
Greutate 350 grame

Cod	Culoare	Tip	mm
843505	roșu	56 lame	70x55x(H)260



630006



630303

**TAVĂ CARNE/CARTOFI PRĂJIȚI**

Cod	mm
630303	470x310x(H)75

**SOLNIȚĂ SARE**

Cu capac cu filet

Cod	mm
630136	Ø80x(H)175

SOLNIȚĂ PIPER

Cu capac cu filet

Cod	mm
630235	Ø63x(H)100



630808

**STRECURĂTOARE CARTOFI PRĂJIȚI - ALUMINIU**

Fund fix și strecurătoare detașabilă

Cod	mm
630006	Ø400x(H)170

**STRECURĂTOARE CARTOFI PRĂJIȚI**

Oțel inoxidabil

Cu mâner din oțel inoxidabil

Cu fund detașabil

Cod	mm
630808	Ø410x(H)170



630716

**TĂIETOR CÂRNAȚI**

Cod	mm
630716	200

**SOLNIȚĂ SARE**

Cu capac cu filet

Cod	mm
630105	Ø80x(H)195

SOLNIȚĂ PIPER

Cu capac cu filet

Cod	mm
630204	Ø65x(H)120



632802

FILTRU DE GRĂSIMI PENTRU FRITEUZECutie cu 50 de bucăți
Nețesute

Cod	ØxH mm
632802	245 x 250

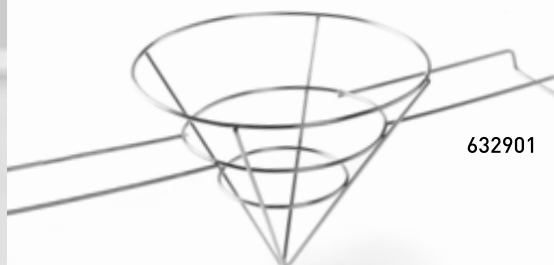

632901

SUPORT FILTRU DE GRĂSIMI PENTRU FRITEUZE**S.S.**
STAINLESS STEEL

Cod	ØxH mm
632901	250 x 200



196007

GĂLEATĂCu capac
Potrivită pentru depozitarea grăsimii**PP**
POLYPROPYLENE

Cod	Litru	mm
196007	11,5	Ø220x(H)290

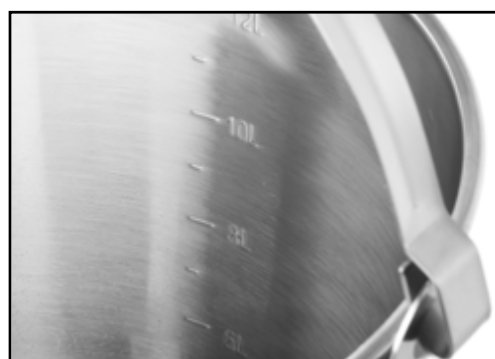

516706

**GĂLEATĂ CU BAZĂ CONSOLIDATĂ**

Gradată

S.S.
STAINLESS STEEL

Cod	Litru	mm
516706	12,0	Ø290x(H)305

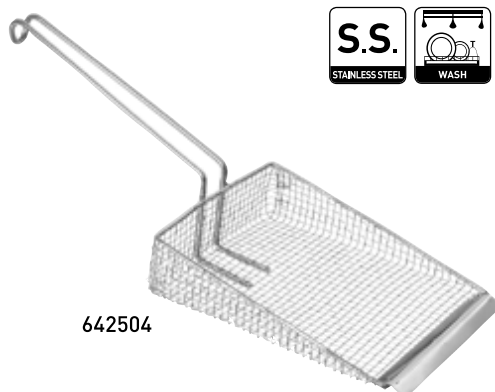

642504

**SCAFĂ CARTOFI PRĂJIȚI**

Cu mâner sârmă cu lungimea de 150 mm

Cod	mm
642504	160x210

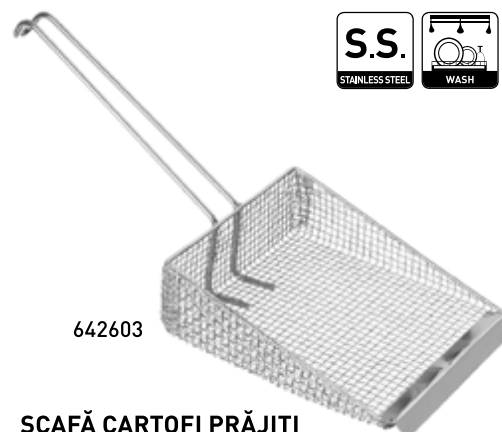

642603

**SCAFĂ CARTOFI PRĂJIȚI**Cu mâner sârmă cu lungimea de 225 mm
Sită dublă

Cod	mm
642603	175x225

NOU!

642566

FĂRAȘ TIP PÂLNIE PENTRU CARTOFI PRĂJIȚIDeschidere 70 mm
Atât pentru stângaci cât și pentru dreptaci

Cod	mm
642566	233x205



642559

**FĂRAȘ TIP PÂLNIE PENTRU CARTOFI PRĂJIȚI**Cu mâner detașabil
Deschidere 70 mm
Atât pentru stângaci cât și pentru dreptaci

Cod	mm
642559	170x170

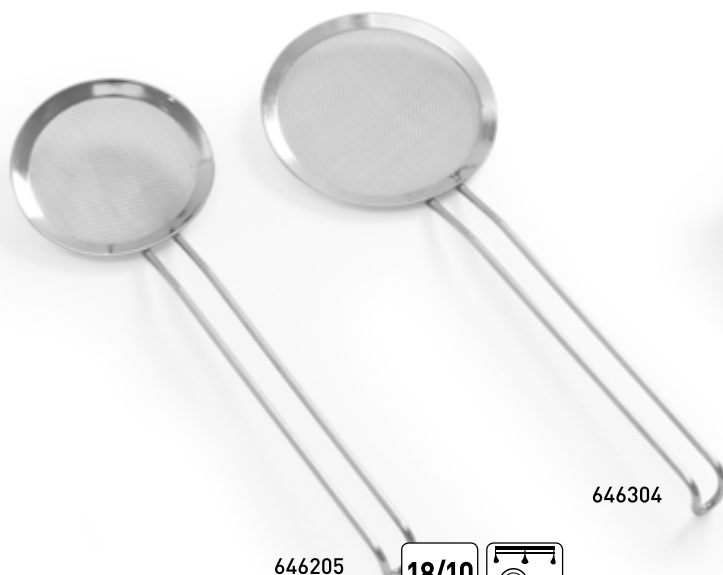

646205

**SEPARATOR GRĂSIME - PLASĂ FINĂ**

Cu mâner din sârmă

Cod	mm
646205	Ø125x350
646304	Ø150x430



646601

**STRECURĂTOARE "CUIB DE PASĂRE"**

Cu mâner din sârmă și clip de fixare

Cod	mm
646601	Ø80/Ø100x395

PALETE CARTOFI PRĂJIȚI



PALETĂ CARTOFI PRĂJIȚI

Oțel inoxidabil cu mâner din ABS
Adâncă

Cod	mm
640906	Ø220x(L)600
640913	Ø240x(L)600
640920	Ø260x(L)600

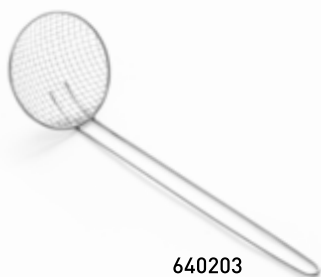

640203



PALETĂ CARTOFI PRĂJIȚI

Cu mâner din sârmă

Cod	mm
640203	Ø125x(L)420



PALETĂ CARTOFI PRĂJIȚI

Cu mâner armat din sârmă

Cod	mm
● 640418	Ø140x(L)515
● 640517	Ø180x(L)540
● 640715	Ø220x(L)605
640814	Ø260x(L)710



PALETĂ CARTOFI PRĂJIȚI

Cu mâner armat din sârmă

Cod	mm
640401	Ø160x(L)450
640500	Ø180x(L)470
● 640609	Ø200x(L)510
● 640708	Ø220x(L)540
● 640807	Ø260x(L)550



640920

640906

640913



640715

640517

640418



640807

640708

640609

CLEȘTI

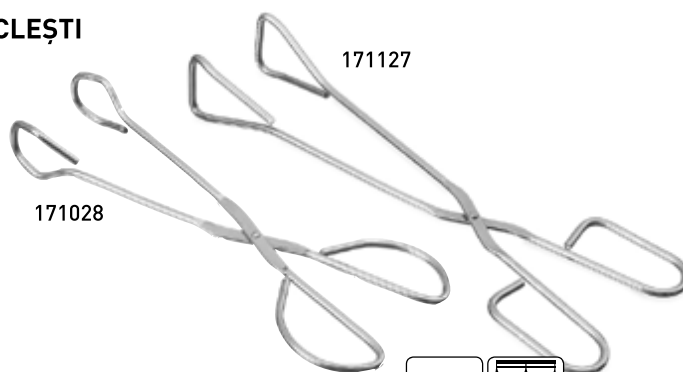

171028

171127

CLEȘTI SERVIRE



Cod		L mm
171028	2 per ambalaj	240
171127	2 per ambalaj	300

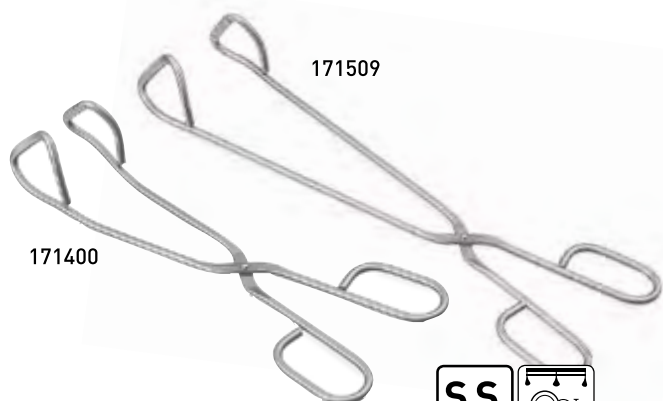

171400

171509

CLEȘTE SERVIRE CURBAT



Cod		L mm
171400		240
171417	1 per ambalaj	240
171509		300
171516	1 per ambalaj	300



171318

171325

171301

CLEȘTI SERVIRE



Cu silicon rezistent la căldură pe clești
Cu blocare

Cod	L mm
171301	240
171318	300
171325	400

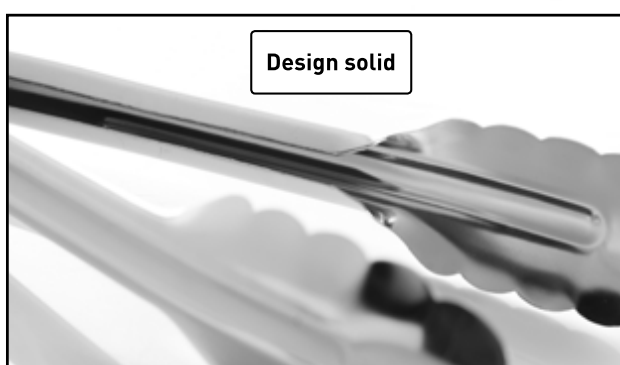

Cel mai vândut!

**CLEȘTI SALATĂ**Cu clip de fixare
Design solid

Cod	-	L mm
171707	1 per ambalaj	250
171806	1 per ambalaj	300
171905	1 per ambalaj	400



524008

CLEȘTE UNIVERSALCu clip de fixare
Detașabil

Cod	-	L mm
● 524008		280
524022	2 per ambalaj	280



171752

171851

CLEȘTI SERVIRE

Cu mâner din PVC negru



Cod	-	L mm
171752	1 per ambalaj	250
171851	1 per ambalaj	300

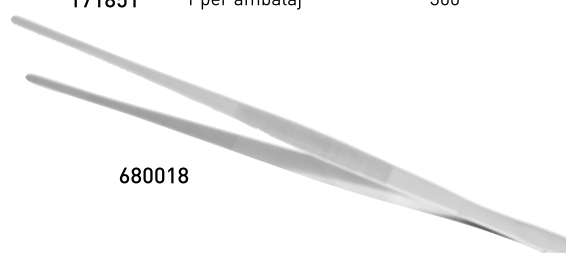

680018

PENSETĂVersiunea lungă
Potrivit pentru extragerea
oaselor de pește sau pentru
manevrarea produselor fierbinți

Cod	-	L mm
680018	1 per ambalaj	300

RĂZUITOARE



855713

855102

SPATULE HAMBURGER



855508

855607



855676

855652



855737

855669



855720

RĂZUITOR

Cu mâner din lemn



Cod		mm
855102		118x100x(L)251
855119	1 per ambalaj	118x100x(L)251

RĂZUITOR



Cod		mm
855713		80x108x(L)251

SPATULĂ HAMBURGER

Cu mâner din lemn



Cod		mm
855508		120x75x(L)280
855607		150x110x(L)305



SPATULĂ HAMBURGER

Cod		mm
855676		100x76x(L)275
855652		140x105x(L)308



PALETĂ

Cod	mm	Grosime (mm)
855669	150x95	1,2
855737	200x73	1



PALETĂ FLEXIBILĂ, PERFORATĂ

Cod	mm	Grosime (mm)
855720	210x73	1



PALETĂ

Pentru produse de cofetărie
Lamă netedă

Cod	mm
855706	110x17
855690	203x34
855744	250x39



CUȚIT PALETĂ

Cu lamă flexibilă

Cod	mm
855775	110x19
855782	200x32
855683	254x37

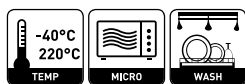
**LINGURĂ BUCĂTĂRIE PBT**

Cod	mm
563007	Ø70x380
563106	Ø80x450
563205	Ø105x600



563007



563106



563205



659700



659809



525005

**LINGURĂ EXOGLASS**

Fabricat din material Exoglass

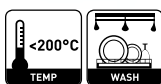

Cod	mm
659700	300
659809	380

LINGURĂ LEMNLemn
Set de 3 bucăți

Cod	mm
525005	300-350-400



525104



658000

SPATULĂ

Lemn



Cod	-	mm
525104		260
525142	set de 4 bucăți	260

SPATULĂ

Cod	mm
658000	280



659601



659502

SPATULĂ

Cod	mm
659601	320

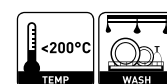
SPATULĂCu fante
Din plastic exoglass

Cod	mm
659502	300



659205



659304



659403

SPATULĂ

Mâner din ABS

Lamă din cauciuc sintetic



Cod	mm
659205	50x80x(L)250
659304	70x115x(L)350
659403	70x115x(L)450



659014



659007



659106

SPATULĂ

Mâner din polimer plastic

Lamă din silikon



Cod	mm
659014	70x115x(L)254
659007	70x115x(L)350
659106	70x115x(L)450



658604



658703



658802



658901

**SPATULĂ**

Mâner din fibră de sticlă armat cu nylon

Lamă din cauciuc

Cod	mm
658604	55x90x(L)250
658703	55x90x(L)320
658802	55x90x(L)420
658901	100x150x(L)520

Lamă în formă
de lingură**NOU!**

659458



659465



659472

**SPATULĂ ÎN FORMĂ DE LINGURĂ**

Mâner din ABS

Lamă din cauciuc sintetic

Cod	mm
659458	57x87x(L)254
659465	75x112x(L)356
659472	75x117x(L)408

LINGURI ȘI POLONICE SERIA PROFI LINE

Profesionale, o singură bucată fără sudură, în conformitate cu standardele HACCP

Oțel inoxidabil dur

Grosime 4 mm

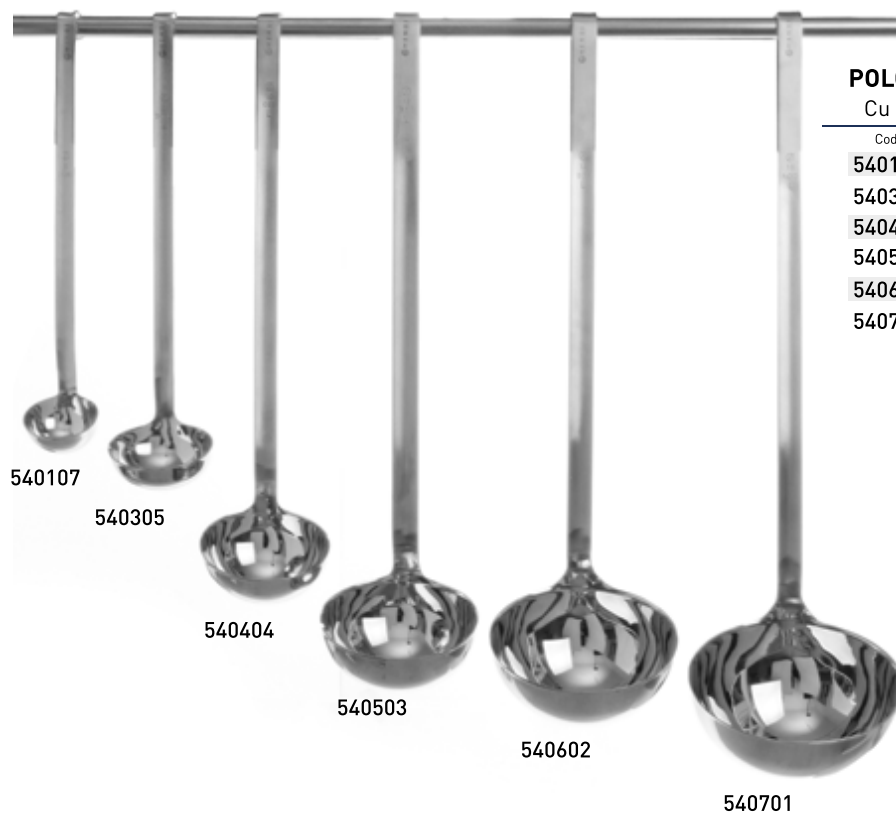

POLONIC

Cu margine anti-picurare

Cod	Litru	Dimensiune (mm)
540107	0,05	Ø60x300
540305	0,125	Ø80x320
540404	0,25	Ø100x400
540503	0,5	Ø120x450
540602	0,75	Ø145x440
540701	1	Ø165x480

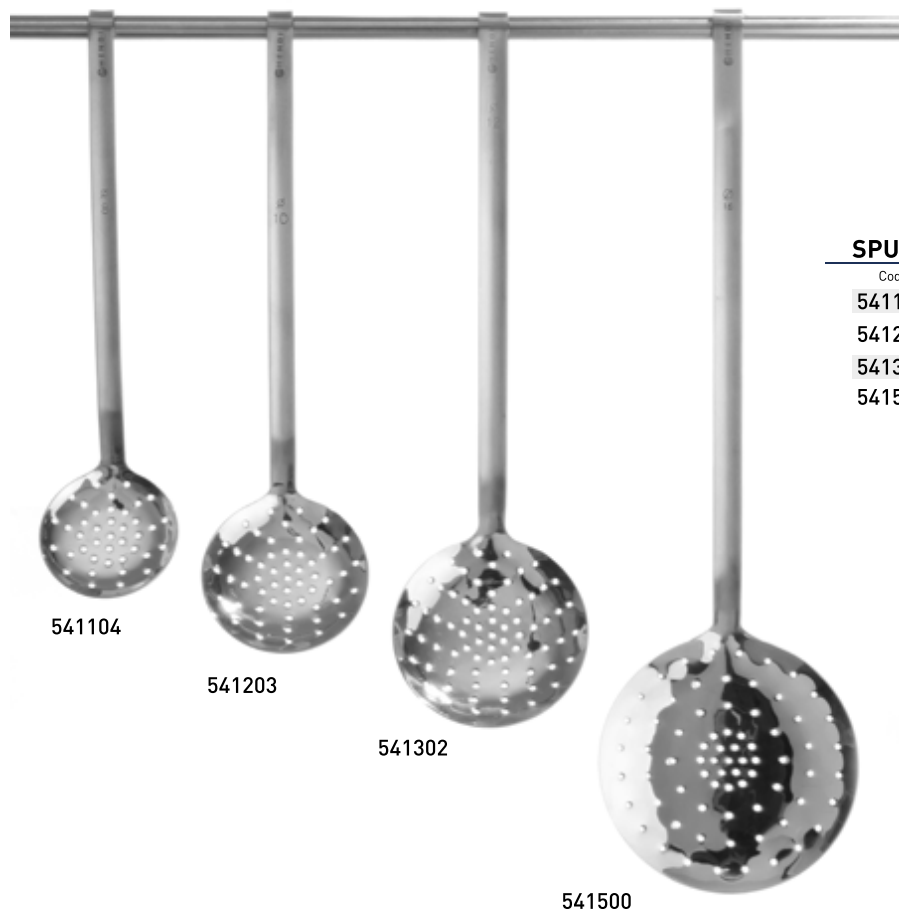
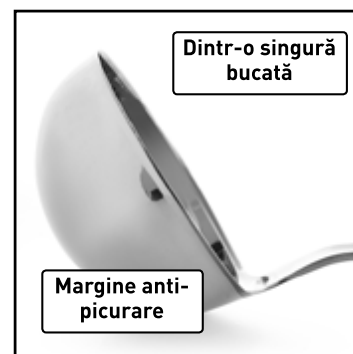

SPUMIERĂ

Cod	Dimensiune (mm)
541104	Ø80x390
541203	Ø100x400
541302	Ø120x460
541500	Ø160x530



LINGURĂ SOS

Cod	Dimensiune (mm)
542606	100x65x430

LINGURĂ LEGUME

Cod	Dimensiune (mm)
542507	100x65x480

FURCULIȚĂ FRIPTURĂ

Cod	Dimensiune (mm)
542705	35x350

SPATULĂ

Cod	Dimensiune (mm)
542200	100x110x510



LINGURI ȘI POLONICE SERIA KITCHEN LINE

1 bucată întregă, fără sudură
Conforme HACCP

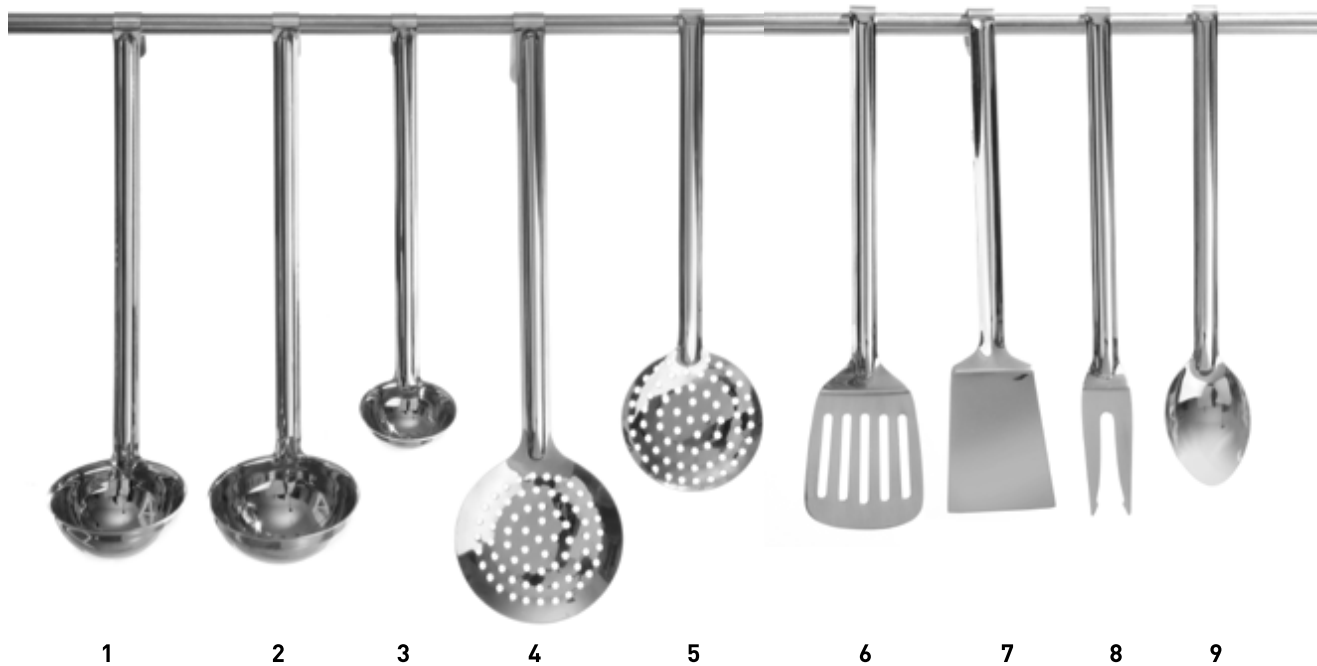

Cod	Nº	Nume	Litru	mm
527207	1	Polonic	0,18	Ø90x360
527306	2	Polonic	0,21	Ø100x380
527108	3	Polonic	0,05	Ø60x300
528204	4	Spumieră		Ø130x385
528105	5	Spumieră		Ø100x340
526118	6	Spatulă cu fante		340
526101	7	Spatulă		340
526200	8	Furculiță friptură		35x350
526309	9	Lingură legume		325

BOLURI, TELURI ȘI STRECURĂTORI

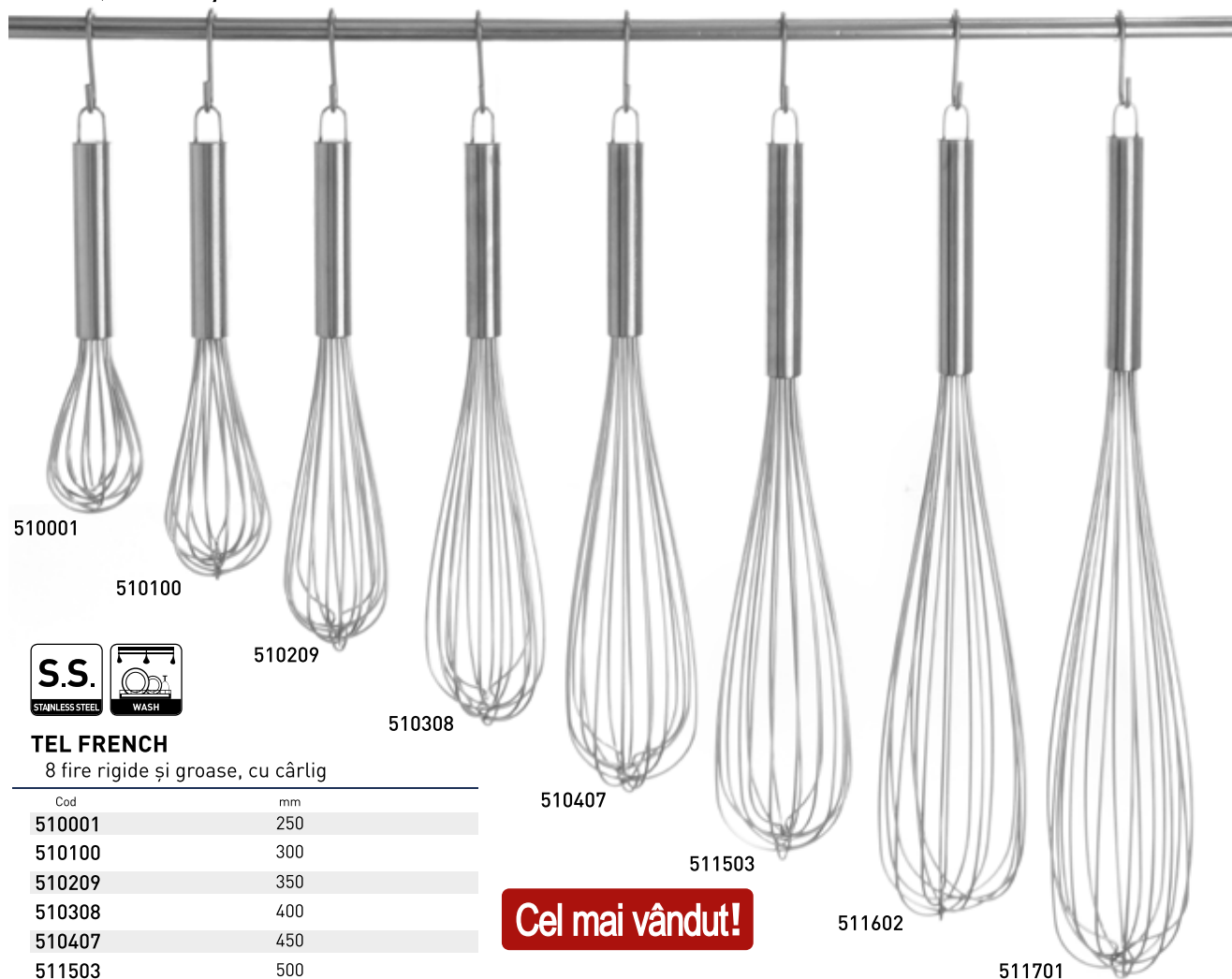

510001

510100

510209

510308

510407

511503

511602

511701

**TEL FRENCH**

8 fire rigide și groase, cu cârlig

Cod	mm
510001	250
510100	300
510209	350
510308	400
510407	450
511503	500
511602	550
511701	600

Cel mai vândut!**TEL PIANO**

7 fire subțiri, flexibile, cu cârlig

Cod	mm
532003	200
532102	250
532201	300
532300	350

**TEL**

Cod	mm
856109	160



856109



532003

532102

532201

532300

**Foarte
flexibil**



BOL BUCĂTĂRIE

Cod	Litru	mm
● 530108	0,8	Ø160x(H)63
530207	1,3	Ø205x(H)70
530306	1,6	Ø225x(H)83
● 530405	2,3	Ø250x(H)84
530504	3,1	Ø280x(H)99
530603	5,0	Ø315x(H)108
● 530702	6	Ø345x(H)118

BOL AMEȘTECARE - CU BAZĂ ROTUNDĂ

Cod	Litru	mm
● 517109	0,7	Ø158x(H)55
517208	1,4	Ø197x(H)68
● 517307	2,3	Ø240x(H)88
517406	3,3	Ø259x(H)92
● 517604	4,9	Ø300x(H)118

STRECURĂTORI



833506

COȘ FIERBERE PASTE

Potrivite pentru oala Ø 360 mm - cod produs 831700

Cu cârlig suplimentar pentru sprijinire în timpul scurgerii

Cod	mm
833506	160x(H)230



535523

STRECURĂTOARE PROFI LINE

Cu bază și 2 mânere nituite

Cod	mm
535509	Ø320x(H)180
535516	Ø360x(H)200
535523	Ø400x(H)220



530702



530405

530108



517604



517307

517109

NOU!



535424

535417

535400

STRECURĂTOARE PERFORATĂ

Cu bază și 2 mânere

Cod	mm
535400	Ø235x(H)85
535417	Ø285x(H)115
535424	Ø315x(H)120



535301

535103

535202

STRECURĂTOARE KITCHEN LINE

Cu bază și 2 mânere

Cod	mm
535103	Ø240x(H)125
535202	Ø280x(H)135
535301	Ø340x(H)160



635001

635209

635407

635605

SITĂ

Cu mâner sârmă

Cod	mm
● 635001	Ø120x280
635155	Ø160x320
● 635209	Ø180x340
635308	Ø200x360
● 635407	Ø230x400
● 635605	Ø250x435



639009

639016

639023

SITĂ CU PLASĂ DUBLĂ

Mâner lemn

Suport solid

Cod	mm
639009	Ø260x570
639016	Ø310x800
639023	Ø360x860



638309

638507

638705

638903

SITĂ - PLASĂ FINĂ

Cu mâner sârmă

Cod	mm
638309	Ø100x250
638507	Ø150x345
638705	Ø200x400
638903	Ø250x455

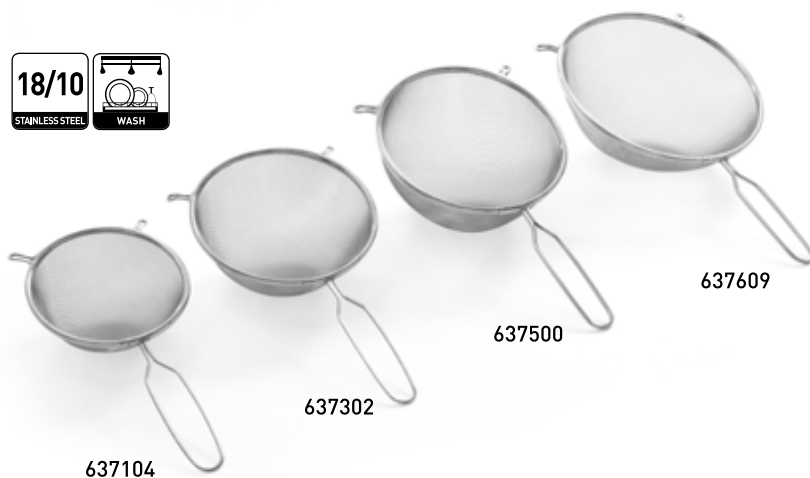
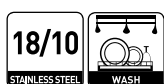

637104

637302

637500

637609

SITĂ

Cu mâner sârmă

Cod	mm
● 637104	Ø160x305
637203	Ø180x325
● 637302	Ø200x360
637401	Ø220x380
● 637500	Ø240x410
● 637609	Ø260x440

SITE CONICE



647509

647516

SITĂ CONICĂ CU PLASĂ DE SÂRMĂ **18/10**

Plasă fină cu mâner din sârmă

Cod	mm
647516	ø160x355
647509	ø180x395

STAINLESS STEEL

NOU!

647561

647554

SITĂ CONICĂ CU PLASĂ DE SÂRMĂ PE JUMĂTATE **18/10**

Plasă fină

Cod	mm
647554	ø200
647561	ø245

STAINLESS STEEL



556719



547502

547304

SITĂ CONICĂ CU MÂNER SUPLIMENTAR**S.S.**
STAINLESS STEEL

Cod	mm
547304	ø185x350
547502	ø235x395

PÂNZĂ STRECURARE

Bumbac

Lavabil până la 95 ° C

Cod	-	mm
556719	1 pe carton	700x700

NOU!

647592

SITĂ LEGUME

Plasă de sârmă fină și piesă presare din lemn

Cu suport și mâner sârmă

Cod	mm
647592	ø200x390

18/10
STAINLESS STEEL

515501

APARAT DE PASAT LEGUMEPerfect pentru prepararea supelor cremă și a sosurilor de roșii
Include 2 lame, grosieră și fină

Cod	mm
515501	ø200

18/10
STAINLESS STEEL

USCĂTOR SALATĂ



222560

222553



USCĂTOR SALATĂ

Ideal pentru uscarea unei cantități mari de legume și fructe după spălare
222560 are un sistem de drenare a apei ușor de utilizat

Coș interior detașabil

Nu este disponibil în Franța

Cod	Litru	mm
222553	12	Ø330x(H)430
222560	25	Ø440x(H)520



222485



USCĂTOR SALATĂ

Ideal pentru uscarea legumelor sau fructelor după spălare

Coș interior detașabil din polipropilenă

Capac din polipropilenă

Bol din plastic SAN



Cod	Litru	mm
222485	4,5	Ø260x220



DISPENSER PENTRU SOS



Cel mai vândut!



STICLE DISPENSER

Dopul ajută la menținerea igienei și păstrează sosul proaspăt mai mult timp

Cod	Ambalat per	Litru	Culoare	mm
558003	1	0,20	galben	Ø50x185
558010	1	0,20	roșu	Ø50x185
558027	1	0,20	transparent	Ø50x185
557808	1	0,35	galben	Ø55x205
557815	1	0,35	roșu	Ø55x205
557822	1	0,35	transparent	Ø55x205
557907	1	0,70	galben	Ø70x240
557914	1	0,70	roșu	Ø70x240
557921	1	0,70	transparent	Ø70x240

SET DE 3 STICLE DISPENSER

Dopul ajută la menținerea igienei și păstrează sosul proaspăt mai mult timp

Cod	Ambalat per	Litru	Culoare	mm
558034	3	0,20	galben	Ø50x185
558041	3	0,20	roșu	Ø50x185
558058	3	0,20	transparent	Ø50x185
557839	3	0,35	galben	Ø55x205
557846	3	0,35	roșu	Ø55x205
557853	3	0,35	transparent	Ø55x205
557938	3	0,70	galben	Ø70x240
557945	3	0,70	roșu	Ø70x240
557952	3	0,70	transparent	Ø70x240

STICLĂ MUȘTAR ȘI KETCHUP

Sticle cu secțiune transversală ovală, ușor de stors

Fund rotunjit spre exterior pentru o bună stabilitate

Capacitate mare

Cod	Litru	Culoare	mm
558218	0,6	ocru	Ø83x194
558225	1,1	ocru	Ø97x255
558232	0,6	roșu	Ø83x194
558249	1,1	roșu	Ø97x255





551806



Cu trei duze diferite
(Ø 2, 4 și 6 mm)

PÂLNIE PENTRU COFETĂRIE

Mâner ergonomic din polipropilenă
Designul supapei de oprire asigură o etanșare strânsă
Suport tijă și vas de scurgere
Este proiectată pentru dozarea sosurilor cu diferite consistențe: pentru maioneză, creme, ciocolată lichidă sau la decorarea farfuriilor folosite pentru servire și a produselor de patiserie

Cod	Litru	mm
551806	1,5	Ø190x(H)220



INEL PRĂJITURI

Perfect pentru conturarea prăjiturilor și a mâncărilor

Cod	mm
512104	Ø 70x(H)45
512302	Ø 90x(H)50



512104

512302



● 512 302



624302

CEAINIC - CU CAPAC
Mâner solid din bachelită



Cod	Litru	mm
624302	6,5	Ø260



516706

GALEATĂ CU BAZĂ CONSOLIDATĂ
Gradată



Cod	Litru	mm
516706	12,0	Ø290x(H)305



518700

PÂLNIE



Cod	mm
518700	Ø120



462904

CANĂ ULEI
Capac semi-rabatabil



Cod	Litru	mm
462904	0,3	Ø70x(H)115

SCAFE

Cel mai vândut!

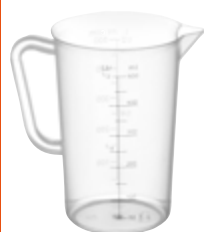

567104



567302



567500



CANĂ GRADATĂ DIN POLIPROPILENĂ

Cod	Litru	mm
● 567104	0,5	Ø90x(H)140
567203	1,0	Ø110x(H)170
● 567302	2,0	Ø140x(H)215
567401	3,0	Ø160x(H)240
● 567500	5,0	Ø190x(H)270



516102

516201

516300

CANĂ GRADATĂ DIN OȚEL INOXIDABIL

Construcție solidă



Cod	Litru	mm
516102	0,5	Ø90x(H)110
516201	1,0	Ø120x(H)135
516300	2,0	Ø140x(H)175



521304

521502



SCAFĂ

Cod	Litru	L mm
521205	0,125	180
521304	0,2	210
● 521403	0,3	250
521502	0,5	265
521526	0,5	265
● 521601	0,65	310
521809	2	400



562000

562017



SCAFĂ

Cod	Litru	L mm
562000	0,125	187
562017	0,25	250